

EN LED spotlight with motion detector

theLeda S8-100 WH	1020800
theLeda S8-100 BK	1020801
theLeda S17-100 WH	1020802
theLeda S17-100 BK	1020803



1. Basic safety information



Assembly and installation should only be carried out by a qualified electrician, somebody who has completed appropriate professional training and has the knowledge and experience necessary to be able to recognise and avoid the potential dangers posed by electricity.



Before installation/disassembly, disconnect the power supply and ensure that the parts are no longer live.



Prior to start-up and using the product, read and observe the operating instructions.

⚠ Only intended for installation out of arm's reach.

① The LED spotlight with motion detector (PIR) conforms to EN 60598-1 and EN 60669-2-1 if correctly installed.

① Optional with corner angle (9070969/907098 and distance frame (9070971/9070988).

2. Proper use

- LED spotlight is used for lighting, depending on presence and brightness
- Device is for wall mounting inside and outside
- For entrances, garages, gardens, corridors, parks, etc.

① Lamp cannot be replaced.
Replace entire spotlight if defective!

3. Connection

⚠ Secure device with an upstream type B or type C circuit breaker (EN 60898-1) with a maximum of 10 A.

Standard connection

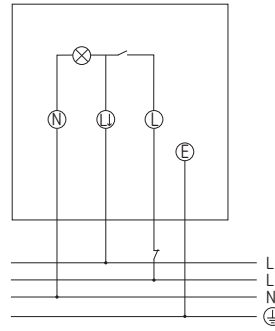

Master/Slave connection

① Max. 8 devices switchable as Master/Slave!

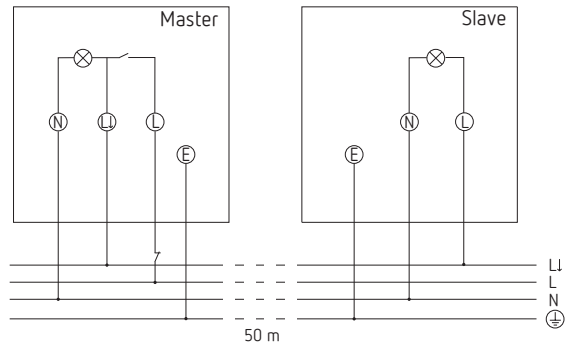

Master/Master connection

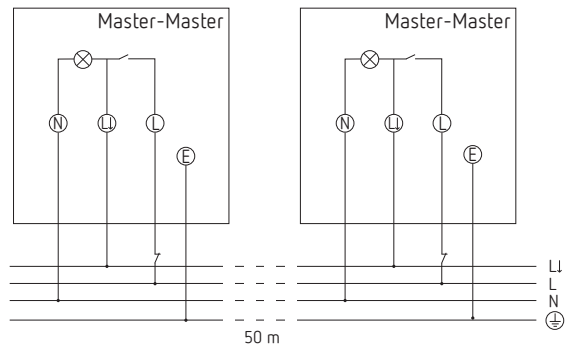

Time delay with master/master switching

If the devices are switched on via port L ↓ the time delay of the triggered device applies to all connected devices.

Time delay of 10 s at master 1

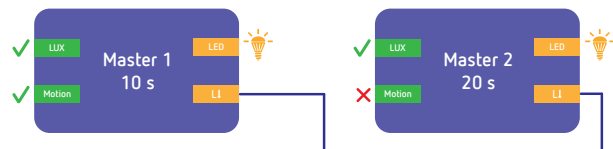

Time delay of 20 s at master 2

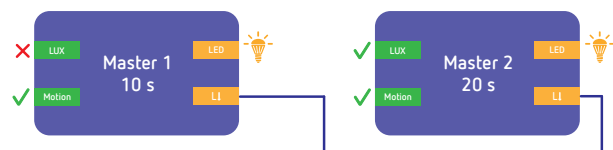

If several devices simultaneously fulfil the conditions for motion and brightness, all masters remain switched on, as long as a time delay elapses.

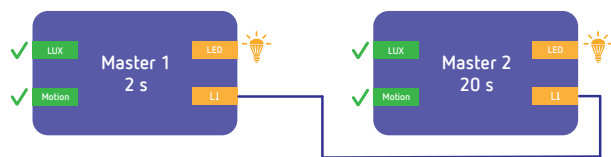

If several masters meet brightness and motion conditions consecutively, all time delays will elapse individually, the last time delay will leave all devices switched on.

4. Installation

Installation instructions

- 1 Observe the recommended installation height of 1.8 m–2.5 m!

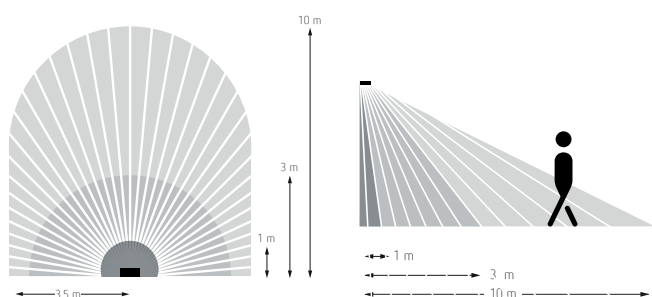

As the motion detector responds to variations in temperature, avoid the following situations:

- 1 Do not point the device at objects with highly reflective surfaces such as mirrors or glass surfaces.
- 1 Do not install the LED spotlight near heat sources, such as heating outlets, air conditioning systems, lamps etc.
- 1 Do not direct the LED spotlight at objects that move in the wind, such as curtains, large plants etc.
- 1 Pay attention to the direction of motion during the test run.

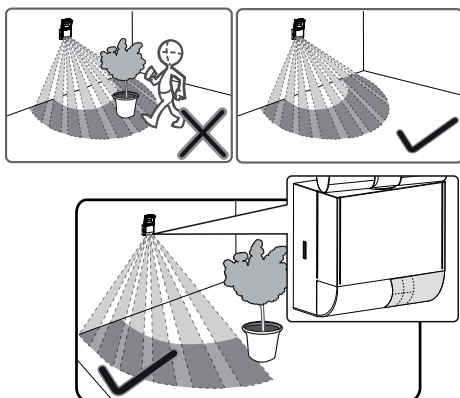

- Disconnect power source.

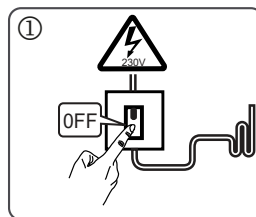

- Use spacer (9070971/9070988) or corner angle (9070969/9070987) (optional).

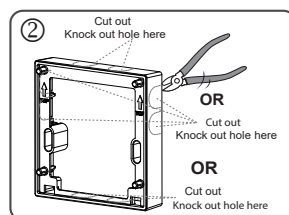

- Loosen catch mechanisms with a screwdriver and remove LED spotlight from base.

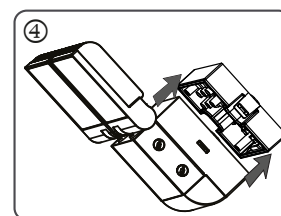
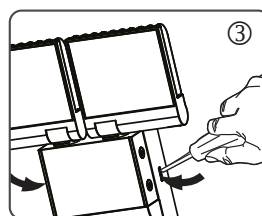

- Make marks for the holes and drill the holes.

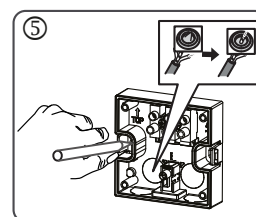

- Guide wire through the socket's seal; fix socket to the wall.

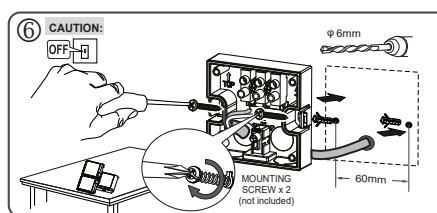

- Fix socket to wall, connect the individual wires to the appropriate terminal and tighten screws.

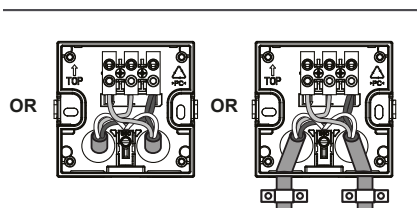
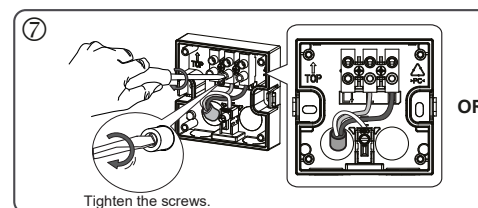

- Place and engage the LED spotlight on the base.

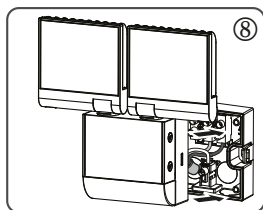

➤ Connect LED spotlight to mains.

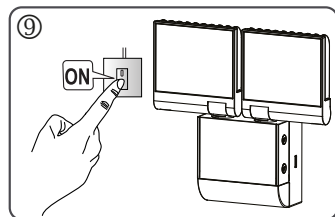

ⓘ The warm-up phase of the device takes approx. 40 s. During this time, the light is switched on.

5. Description

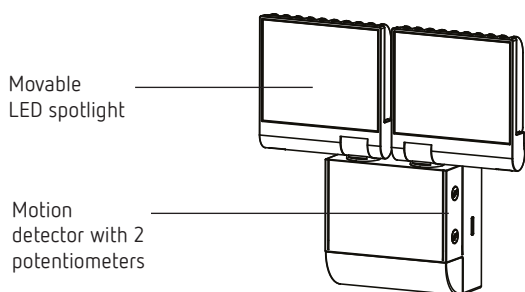

The device has 2 potentiometers for setting time and brightness.

6. Settings

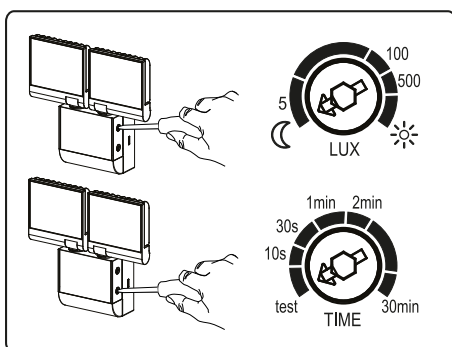

ⓘ The potentiometer settings will be adopted 15 s after the light has gone out.

Setting the brightness

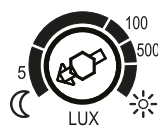

- Turn the potentiometer towards „Moon“; the LED spotlight only switches on when it is relatively dark.
- Turn the potentiometer towards „Sun“; the LED spotlight switches on when it is relatively bright.
- Turn the potentiometer to „Sun“, and the device works independent of brightness.

Setting the time

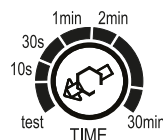

- Set the potentiometer to the desired time (10 s–30 min).

Manual operation

The lighting can be switched on manually via a circuit breaker button.

- ⓘ A circuit breaker button must be connected.
- ⓘ Function only possible at night.

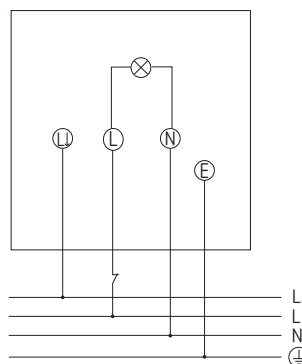

- Quickly confirm Circuit breaker 2 x (within 2 s).
→ The lighting remains switched on for 6 hours.
- To switch off the lighting and return to auto mode, press the circuit breaker briefly (within 2 s).
- If the circuit breaker is pressed x2 during this six second turn-on time, the lighting is switched on again for 6 hours.

7. Walking test

The walking test is used to test the detection area and to restrict it if necessary.

- Set potentiometer „brightness“ to „sun“.
- Turn the „time“ potentiometer counterclockwise up to the stop.
→ The motion detector now always reacts to movements (independent of brightness).
- Walk through the detection area at a right angle. After the motion detector has detected a movement, it switches on for 2 s.

ⓘ Pay attention to the direction of motion during the test.

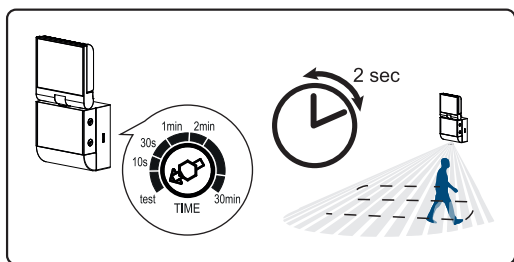

8. Aligning the LED spotlight

theLeda S8-100

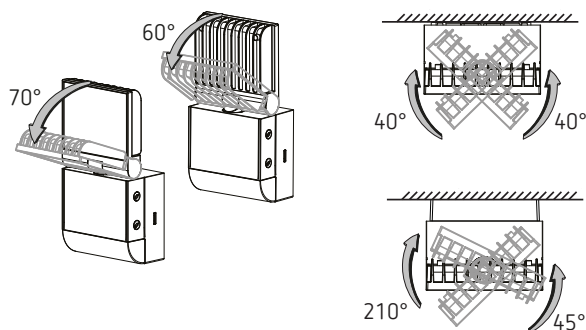

theLeda S17-100

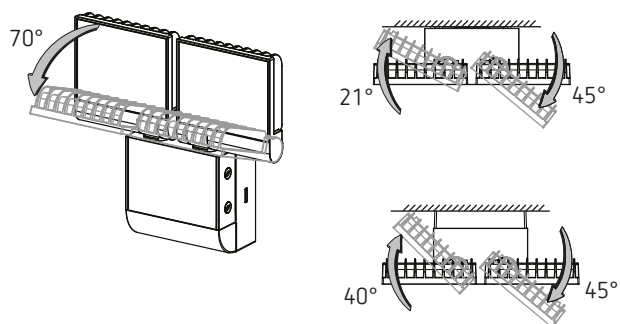

9. Limiting the detection area

- Use enclosed stickers to adjust the motion detector to the desired detection area.
- Remove the required section of the sticker by using scissors.
- Then stick to the lens.

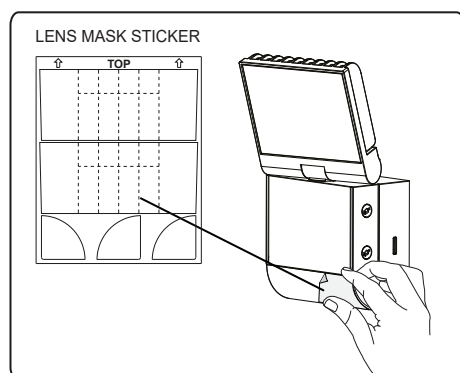

10. Technical Data

Operating voltage:	230 V AC, +10 % / -15 %
Frequency:	50 Hz
Consumption with light On:	8,5 W/17 W
Standby output:	< 0.4 W
LED output (lighting current):	900 lm/2 x 900 lm
Colour rendering index:	80
Colour temperature:	4000 K
Service life:	L70/B50 50.000 h
Protection rating:	IP 55 in accordance with EN 60529
Protection class:	II in accordance with EN 60598-1
Operating temperature:	-20 °C ... +55 °C
Brightness setting range:	2 – 500 lx / ∞ lx
Duty cycle range:	10 s – 30 min
Detection angle:	180°
Detection area:	
lateral:	10 m
frontal:	3 m
incandescent/halogen lamp load	500 W
Low-voltage halogen lamps (transformer):	300 VA
Fluorescent lamps (EVG)	200 W
Compact fluorescent tubes EVG	90 W
LED lamps < 2 W:	20 W
LED lamps > 2 W:	100 W
Mass / dimensions:	1020800+1020801: 242 g / 80 x 160 x 50 mm 1020802+1020803: 298 g / 167 x 160 x 50 mm
This product contains a light source of energy efficiency class D.	

Cleaning and service

- Only use a dry, soft cloth to clean the device surface.
- Do not use any cleaning agents or solvents.

Disposal

- Dispose of device in environmentally sound manner (electronic waste).

11. Contact

Theben AG
 Hohenbergstr. 32
 72401 Haigerloch
 GERMANY
 Phone +49 7474 692-0
 Fax +49 7474 692-150

Hotline
 Phone +49 7474 692-369
 hotline@theben.de

Addresses, telephone numbers, etc.
www.theben.de